

MAGICFX[®] STADIUM SHOT



PRODUCT CODE : MFX0401
VERSION : 1.0
DATE : 11.01.2013



1. CONGRATULATIONS!

You have bought a great new product from MAGICFX®.

MAGIC FX is a Dutch manufacturer of professional special effects machines and equipment. We have been experts in special effects since our establishment in 1995. All our products are made under the brand name MAGICFX® which by now has acquired a great reputation on account of its quality and reliability. All products are made in accordance with the European Machinery Directive. MAGIC FX manages the entire production process in-house, from the design stages and prototyping to production. In short, we cover everything from concept to ready-to-use product.



Moreover, MAGIC FX is Europe's largest supplier of high-quality and fireproof confetti products and streamers. Thanks to our very large stock levels, we can deliver quickly and at low prices.

MAGICFX® is used by special effects professionals all over the world and our products are distributed through a dealer network which covers more than 80 countries.

Congratulations and enjoy your purchase!

MAG:CFX®

2. CE MARKING

	<p>PLEASE NOTE: We presume that you, your employees and others who use or come into contact with the machine are familiar with how the machine must be dealt with. This includes the correct use, maintenance and repair of the machine as described in this user manual. This also means that the employees are familiar with the use of machines through training or experience.</p>
	<p>DANGER WARNING: Only use the Stadium Shot in accordance with the regulations and instructions in this manual. Consult MAGIC FX in case of doubt.</p>

Disclaimers:

MAGIC FX B.V. excludes liability for unsafe situations, accidents and damage that are the result of:

- Disregard for the warnings or regulations as set out on the Stadium Shot or in this documentation.
- Use for other purposes or under other circumstances than those set out in this documentation.
- Alterations to the Stadium Shot. This also includes the use of replacement parts other than the original ones.
- Insufficient maintenance.
- Unauthorised removal of safety caps and/or safeguards.
- Incompetent operation of the machine.

MAGIC FX B.V. is not liable for any consequential loss in the event of a Stadium Shot breakdown.

© Copyright 2012

All rights are reserved. Nothing from this manual may be duplicated, or kept in an automated data file, or made public, or in any form or manner, whether electronically, mechanically, by photocopying, by incorporation, or in any other manner duplicated without the permission of MAGIC FX B.V.

MAGIC FX at all times retains the right to make alterations without the direct knowledge of the client. The contents of this user manual can also be changed.

Please contact the technical department of your supplier for extra information with regard to, for example, maintenance and repair. This user manual has been drawn up with the utmost care. MAGIC FX cannot be held responsible for any mistakes made in this publication or for any consequences thereof.

3. DECLARATION OF CONFORMITY

DECLARATION OF CONFORMITY - Module B+C1
Art. 9 / 10 + Att II - Directive 97/23/EC (PED)



COMPRESSED AIR TANK

Code MFX0401	Drawing M671844
Manufacturer MAGIC FX B.V.	Year
Type STADIUM SHOT	Mark S10C 16 N 1
Design pressure 8,0 bar	Pneumatic pressure test 8,8 bar
Min. Design metal temperature 0°C	Max. Design metal temperature 70°C
Capacity 33,0 L	Category II
Approval nr. 03 CPB 05 07 01 dtd.	
Applied norms VSR – pressure calculations AD Merkblätt – Fatigue Stress AD Merkblätt – Pressure test	
Notified Body ICEPI SpA EU nr. 0066	
Approved MAGIC FX drawing M680927 rev.A	PED Module B + C1

Pressure test 8,8 bar	Test time 3 minutes	Pressurizing fluid Filtered air
---------------------------------	-------------------------------	---

The Stadium Shot passed the MAGIC FX test procedure





4. FOREWORD

This manual describes the MAGICFX® Stadium Shot. The information in this manual is important for the proper and safe functioning of the Stadium Shot. If you are not familiar with the installation, operation, preventative maintenance etc. of the Stadium Shot then please read this user manual carefully from beginning to end. MAGIC FX also insists that all new users (operators, installers, maintenance workers and cleaners) receive a training course in which this user manual can serve as a starting point.

MAGIC FX advises that the original of this user manual, including appendices, is kept at a safe and central place. It is best that another original or copy is kept close to the Stadium Shot at the workplace.

If you are familiar with these matters, then you can use this manual as a work of reference.

The following standard markings are used in this manual for drawing attention to certain subjects or actions.

	<p>TIP: Gives you suggestions and advice regarding easier or more convenient ways to carry out certain tasks.</p>
	<p>PLEASE NOTE: A comment with additional information: alerts you to certain problems.</p>
	<p>CAUTION: The machine can be damaged if you do not follow the procedures carefully.</p>
	<p>DANGER WARNING: You can get (seriously) hurt if you do not carefully carry out the procedures.</p>

CONTENTS

1.	CONGRATULATIONS!	1
2.	CE MARKING.....	2
3.	DECLARATION OF CONFORMITY.....	3
4.	FOREWORD	4
5.	INTRODUCTION	6
5.1	DESCRIPTION AND APPLICATION OF THE STADIUM SHOT.....	6
5.2	NECESSARY ACCESSORIES.....	6
5.3	CONFETTI & STREAMERS	7
6.	SAFETY	8
6.1	INTRODUCTION	8
6.2	GENERAL SAFETY RULES.....	8
6.3	WARNINGS.....	9
7.	ONDERDELEN.....	10
8.	ACCESSOIRES.....	11
9.	PREPARATIONS	12
10.	INSTALLATION	13
11.	USAGE	17
12.	SWITCHING OFF	18
13.	TROUBLESHOOTING	20
14.	TECHNICAL SPECIFICATIONS	20
15.	MAINTENANCE	20
16.	GUARANTEE	20

5. INTRODUCTION

5.1 DESCRIPTION AND APPLICATION OF THE STADIUM SHOT

The Stadium Shot is a confetti shooting system which has been specially developed for shooting confetti or streamers in a stadium or at another outdoor location.

Any use other than that described above will exclude your supplier from any liability.

5.2 NECESSARY ACCESSORIES

The following parts belong to the Stadium Shot:

		
<p>Manual</p>	<p>MFX0405 – Compressor</p>	<p>Hose</p>
		
<p>MFX0407 – Pressure Caps & Lifting Cores</p>	<p>Confetti of Streamers</p>	

Table 5.1

5.3 CONFETTI & STREAMERS

The Stadium Shot offers the possibility to shoot various loads.

The following fillings are possible:

INPUT	CONTENTS	WEIGHT	OUTPUT
	<p>PAPER CONFETTI</p>	<p>2 kg</p>	<p>up to 20M</p>
	<p>METALLIC CONFETTI</p>	<p>3 kg</p>	<p>up to 20M</p>
	<p>5m x 0,85cm STREAMER</p>	<p>30 Polybags (1500 streamers)</p>	<p>up to 20M</p>
	<p>10m x 1,5cm STREAMER</p>	<p>25 Polybags (800 streamers)</p>	<p>up to 30M</p>
	<p>10m x 5cm STREAMER</p>	<p>12 Polybags (120 streamers)</p>	<p>up to 30M</p>
	<p>20m x 5cm STREAMER</p>	<p>8 Polybags (80 streamers)</p>	<p>up to 50M</p>

Table 5.2

	<p>CAUTION: Metallic products are somewhat heavier and will therefore achieve a larger output.</p>
---	---

6. SAFETY

6.1 INTRODUCTION

The Stadium Shot has been designed and constructed in such a manner that it can be used safely. This applies to the use, the circumstances and the regulations as described in this documentation. Reading this documentation and following the instructions are therefore necessary for everyone who is authorised to work with the Stadium Shot.

The Stadium Shot must be placed and used in surroundings that preferably:

- Have a reasonably stable temperature of between 0 and 30°C.
- Have a relative humidity degree of no more than 75%.
- Are reasonably free of dust, corrosive gases and high concentrations of organic vapours.
- Are not situated in the vicinity of a source of vibration.

6.2 GENERAL SAFETY RULES

- Only use the Stadium Shot if there are no people, animals or other objects in the direction of the shot pipe within the output distance. The shooting direction is the direction in which the shot pipe on the Stadium Shot is pointed. The output distance depends on the content and pressure of the Stadium Shot.
- Make sure that children, unauthorised people and animals do not obtain access to the Stadium Shot!
- Do not take hold of the Stadium Shot while it is working or is switched on. Also, when the Stadium Shot is not working, the electric cannon may still be filled.
- Safety devices may not be removed or disabled.
- All required safety devices must be in good condition and function properly.
- Ensure sufficient lighting of the surroundings.
- Keep the workplace clean.
- Only authorised persons may carry out work with the Stadium Shot.

6.3 WARNINGS

Warning texts have been attached to the Stadium Shot. With regard to these the following rules apply:

- These texts may not be removed or damaged. The operator must regularly check if this is the case.
- The operator must ensure that the texts are and remain clearly visible and legible.

	<p>DANGER WARNING: One must replace texts or signs if these are absent, damaged or illegible.</p>
---	--

Sign and explanation	Photo
 <p>PIC 616 Follow the instructions</p>	
<p>The operator must be told that he/she may only operate the Stadium Shot after reading the user manual.</p> <p>A warning is given for this by means of the command sign of PIC 616. This sign should be attached to the type sign. See also the photo.</p>	

Sign and explanation	Photo
 <p>PIC 307 Danger: high voltage</p>	
<p>A warning must be given about the machine's high voltage by using the caution sign PIC 307. This sign must be attached to the Stadium Shot. See also the added photo.</p>	

7. ONDERDELEN

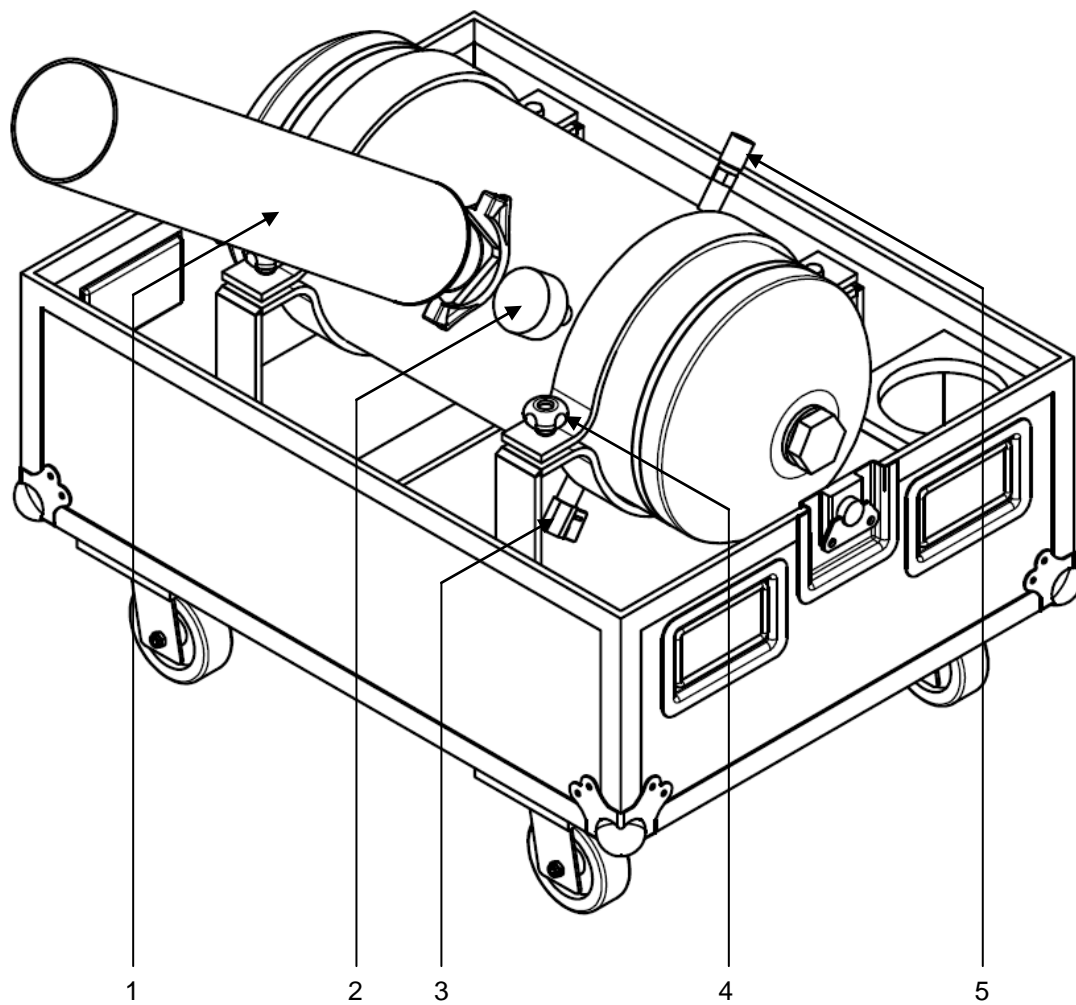

1. Shot pipe
2. Manometer
3. Venting valve
4. Fastening button
5. Input pressure

8. ACCESSOIRES



	
MF0404 – Compression Tape	MF0407 – Pressure Caps & Lifting cores

Table 8.1

You can order these parts and accessories from:

MAGIC FX B.V.
Schouwrooij 27
NL-5281 RE BOXTEL
The Netherlands
T. +31(0)411 63 50 13
F. +31(0)411 63 50 12
W. <http://www.magicfx.eu>
E. info@magicfx.eu



9. PREPARATIONS

Unpack the Stadium Shot. Dispose of the packaging material without harming the environment. Inspect the machine for any damage. If damage is noticed this must be reported to MAGIC FX.

1.



Take a carton lifting core and lower this to the bottom of the shooting tube to close off the hole.

Check if the lifting core lies flat!

2.



Now fill the shot pipe with the required type(s) and colour(s) of confetti and/or streamers.

For an extra effect try to mix streamers and confetti!

3.

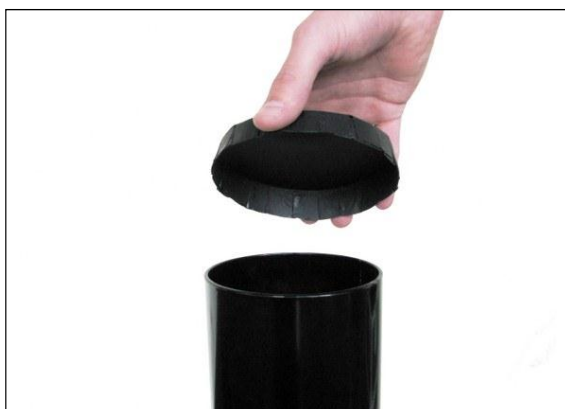



When the shot pipe is fully filled you take, for maximal effect, a pressure cap and place this over the end of the shooting tube to close it off.



Tape the edge of the pressure cap with the special pressure cap tape.

10. INSTALLATION

	CAUTION: The machine can be damaged if you do not follow the procedures carefully.
	DANGER WARNING: The MAGICFX® Stadium Shot may only be installed by adults and authorised persons.

Prepare the Stadium Shot for use as follows:

1.



Place the Stadium Shot on an even, solid and stable surface.

2.



Open the cover of the Stadium Shot.

3.



Take the filled shot pipe from the holder in the flight case.

4.



Screw the shot pipe on the screw thread integrated on the tank. Turn it securely until the end of the thread!

Check to make sure there is no more pressure on the tank!

5.



Determine the required direction for the best effect.

6.



Secure the tank by turning the two fastening buttons. Make sure to twist these buttons properly until the tank is entirely secured.

Always check to make sure the tank is firmly secured.

7.



Put all 4 wheels on their brakes and check if the entire flight case is standing stably and securely!

Note: during a shot a backlash is created through which the flight case can move if it has not been properly secured!

8.



Take a compressor (with a maximum pressure output of 8 bar), which meets the safety requirements and standards concerned, and connect the hose to the quick-connect coupling of the tank and the quick-connect coupling of the compressor.

9.



Activate the compressor and fill the tank until the compressor turns off or the manometer indicates that the pressure in the tank is 8 bar.

Make sure that the pressure does not exceed 8 bar!!
You may disconnect the compressor after filling the tank.

Watch the pressure closely.

The pressure in the tank can increase in case of high temperatures. If the pressure exceeds 8 bar, then use the ventilation valve to remove some air and bring the pressure back to 8 bar (or less).

**CAUTION:**

Always attach the tank properly with the fastening buttons!

Only work with an inspected and certified professional compressor with an air output of no more than 8 bar. Carefully read the manual of the compressor prior to use.

When the Stadium Shot is ready for use never leave the Stadium Shot, the emergency button and the switch unattended!



Make sure that the surroundings of the Stadium Shot are free of people or (moving) objects.

Keep at a safe distance from the public. The recommended distance is at least 25m!

Never leave the tank under pressure for more than 15 minutes.

Regularly check to make sure the pressure in the tank is stable. The pressure can rise through heat. Should this happen then immediately open the venting valve and let the air escape until the pressure level drops below 8 bar!

11. USAGE

	<p>TIP: Gives you suggestions and advice regarding easier or more convenient ways to carry out certain tasks.</p>
	<p>CAUTION: The machine can be damaged, if you do not follow these procedures carefully.</p>
	<p>DANGER WARNING: The MAGICFX® Stadium Shot may only be installed by adults and authorised persons.</p> <p>The Stadium Shot may only be operated if all parts are completely and correctly installed/connected.</p>

For using the Stadium Shot take the following steps:

1.



The Stadium Shot will release a shot as soon as the magnetic valve is powered by a 220V electricity source.
Take a 220V switch and make sure that the electricity is switched off!

Then insert the plug into the socket of the switch.

2.



Press the switch to the on (ON) position to enable the Stadium Shot to shoot. Immediately after the shot press the switch again to the off (OFF) position.

12. SWITCHING OFF

To switch off the Stadium Shot, take the following steps:

1.



Disconnect the power cable, the emergency stop and the switch, and put these away.

2.



Disconnect the air hose and remove the compressor.

Check to make sure there is no more pressure on the tank. Remove any remaining pressure by opening the venting valve.

3.



Unscrew the shot pipe from the screw thread integrated in the tank and store these in their flight case holder.

4.



Lastly, check if the machine is complete and if this is the case then place the cover back on the flight case.

13. TROUBLESHOOTING

- The Stadium Shot leaks from the tube.

Remove the pressure from the tank and close the valve. Then connect the compressor, close off the tube with your hand and start the compressor. Let the pressure rise to 2 bar and then take your hand off the tube: the pressure in the Stadium Shot should now increase to rise to 8 bar. If not, repeat this process.

- The Stadium Shot leaks from the flap.

Remove the pressure from the tank and close the valve. Make sure that the Stadium Shot is not connected to an electricity source. Remove the bolts with a wrench and then remove the part of the flap that is loose. Remove the rubber membrane from the flap. Clean the metal part of the membrane. Then mount this back again and firmly screw the flap back on. Repeat these steps for the large part of the flap (6 bolts).

- The Stadium Shot is still malfunctioning after troubleshooting

Always contact your dealer or the technical service of MAGIC FX first in case of uncertainties, questions about the Stadium Shot works or other issues with regard to the Stadium Shot.

14. TECHNICAL SPECIFICATIONS

Measurements and weight	Length:	770mm (30.3")
	Width:	580mm (22.8")
	Height:	750mm (29.5")
	Pipe length	650mm (25.6")
	Pipe diam.	110mm (4.33")
	Weight	70 Kg (154.5lbs.)
	Contents:	33 Liter
	Max. pressure:	8 Bar (115 PSI)
Power	Input:	AC 230V~50-60Hz
	Usage:	100W
Output	Confetti:	Tot 20m
	Streamers:	Tot 30m
	Stadium streamers:	Tot 50m

Design and product specifications can be changed without prior notification.

15. MAINTENANCE

To achieve the maximum service life of the Stadium Shot you must regularly clean the Stadium Shot and test if it is working correctly.

Should the Stadium Shot not work for some reason then please contact MAGIC FX.

	<p>DANGER WARNING: Do not replace parts yourself; always consult MAGIC FX if necessary.</p>
---	--

16. GUARANTEE

A manufacturer's guarantee of 3 years applies to the MAGIC FX Stadium Shot.

- The guarantee expires if the Stadium Shot is used for improper purposes and for applications which are not stated in this manual.
- The guarantee also expires if the machine is used incorrectly or in violation of the regulations.
- The guarantee expires if the machine is altered without permission from the supplier.